

DEMETRA

Support for dial gauges
Base porta comparatore



DIAL GAUGES COMPARATORI

- Support for dial gauges
- Easy handling during checking point of measuring
- Allow to make several measures at the same time
- Hardened steel inox temper
- Base porta comparatore con largo piano d'appoggio
- Permette di effettuare più misurazioni contemporaneamente.
- In acciaio inox temprato

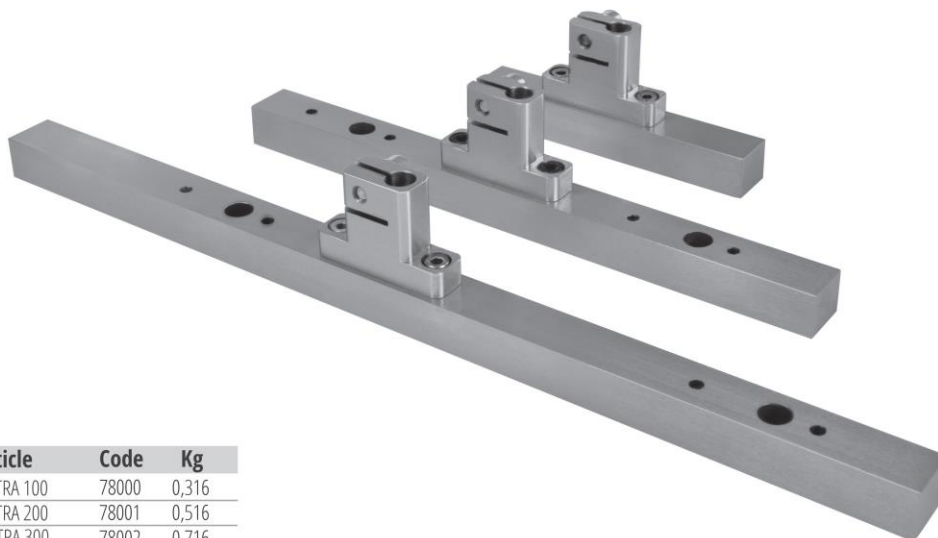

Article	Code	Kg
DEMETRA 100	78000	0,316
DEMETRA 200	78001	0,516
DEMETRA 300	78002	0,716

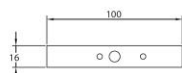
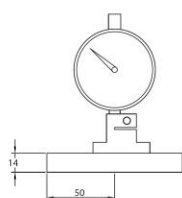

Demetra 100

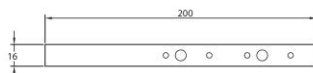
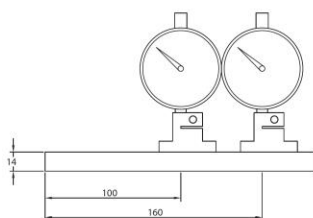

Demetra 200

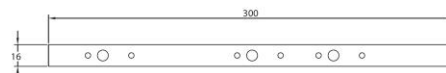
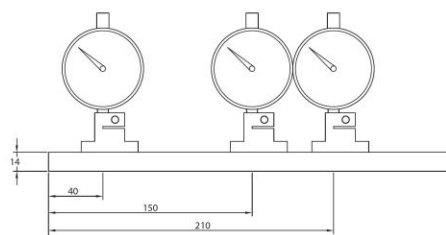

Demetra 300